



## STRIPPING TOOLS

## PRODUCT OVERVIEW

2

Insulation	Type	Order No.	Application range	Insulation thickness	Suggested application	1000V certified	Page
STRIPPING TOOLS FOR EXTERNAL INSULATION	AMS	AV6220	ø > 25 mm	0 - 5 mm	PVC / Rubber		69
	AMS 1000V	17130	ø > 25 mm	0 - 5 mm	PVC / Rubber	X	69
	AMS MAXI	AV6240	ø > 45 mm	0 - 5 mm	PVC / Rubber / Polyethylene		70
	MSU	AE6210	ø 24 - 60 mm	0 - 5 mm	Polyethylene / lead cables		71
	AMX	17300	ø 16 - 54 mm	0 - 5 mm	Polyethylene / fully bonded aluminium outer insulation		72
	AIS	17190	ø 16 - 54 mm	0,5 - 5 mm	High density polyethylene	X	73
	FSI 150	17170	6 - 150 mm <sup>2</sup>	Preadjusted stripping inserts	ABC cables (overhead, twisted, insulated)	X	74
	FSI	AE6200	2,5, 4, 6 and 10 mm <sup>2</sup>		Rigid and flexible single pole	X	75
STRIPPING TOOLS FOR TOOLS FOR SEMICONDUCTOR	FBS	17220	ø 10 - 52 mm	0 - 1,5 mm	Vulcanized, extruded, bonded semiconductive layer		76
	HLS	AV6400	ø 16 - 41 mm	0 - 2 mm	Non vulcanized, peelable semiconductive layer		77
STRIPPING TOOL FOR PRIMARY INSULATION	IMS 20 - 22kV	AV6310 + inserts	25 - 240 mm <sup>2</sup>	Preadjusted stripping inserts	Any type of primary insulation		78
	IMS 10 - 11kV	AV6310 + inserts	25 - 240 mm <sup>2</sup>	Preadjusted stripping inserts	Any type of primary insulation		78
	IMS II	17230	ø 15 - 52 mm	0 - 15 mm	Any type of primary insulation		80
STRIPPING TOOL FOR CHAMFERING PRIMARY INSULATION	UFS	17240	ø 15 - 60 mm		Any type of primary insulation		81
STRIPPING TOOL FOR ARMoured CABLE	Roller chains cutter	1609076	ø 20 - 76 mm cable up to 150 mm <sup>2</sup>		Armoured cable		82



■ STRIPPING TOOLS FOR EXTERNAL INSULATION

- AMS (AV6220)
- AMS 1000V (17131)
- AMS MAXI (AV6240)
- MSU (AE6210)
- AMX (17300)
- AIS (17190)
- FSI 150 (17170)
- FSI (AE6200)

■ STRIPPING TOOLS FOR SEMICONDUCTOR

- FBS (vulcanized / bonded / semiconductor) (17221)
- HLS (not vulcanized / semiconductor / peelable) (AV6410 & AV6411)

■ STRIPPING TOOL FOR PRIMARY INSULATION

- IMS II (17231)
- IMS (AV6310)
- UFS (17241)

■ ARMOURED WIRES

- Roller chain cutter (1609076)

WE

LOVE

TOOLS

# ABI 1

Self adjustable cable stripper

**NEW**

2

ABI 1 Video



## Precision

Cutting depth adjustable up to 3mm, thus no damage to the underlying layers of the cable

## Efficency

Blade suitable for all types of cable insulation

## Handling

No tilting due to axial pulling of the tool in the longitudinal direction

## Safety

The innovative design ensures an injury-free working



## Versatile

Setting of round, longitudinal and spiral cuts

## Protection

The blocking system prevents opening in the position: longitudinal cut. This prevents the blade from breaking off due to misuse

## Ergonomics

The optimally adapted shape of the tool enables fatigue-free working



APPLICATION RANGE	Ø 4,5 - 29 mm
INSULATION THICKNESS	3 mm
SUGGESTED APPLICATION	PVC and rubber

Description	Order No.	Weight	Length
Universal cable stripper	ABI1	150 g	140 mm
Spare blade	110059	-	-

- HANDY AND EFFORTLESS USAGE
- SMALL AND COMPACT DESIGN
- STEP BY STEP DEPTH ADJUSTMENT (IN CLICKS OF 0.1 MM)

- Very small self rotating (<200 mm)
- For every kind of insulation
- Easy to change blade

■ ATTENTION: NOT SUITABLE FOR WORK UNDER VOLTAGE!

2



### Universal cable stripper

APPLICATION RANGE	Ø 0,2 - 6 mm <sup>2</sup>
INSULATION THICKNESS	ANY
SUGGESTED APPLICATION	PVC

Description	Order No.	Length
Universal cable stripper	PTS4	170 mm

- To strip off and cut flexible cables 0,2 - 6 mm<sup>2</sup>
- Integrated blade with safety lock
- Adjustable length

■ ATTENTION: NOT SUITABLE FOR WORK UNDER VOLTAGE!



### Universal cable stripper 0,03 - 16 mm<sup>2</sup>

APPLICATION RANGE	Ø 0,03 - 16 mm <sup>2</sup>
INSULATION THICKNESS	ANY
SUGGESTED APPLICATION	PVC

Description	Order No.	Length
Universal cable stripper	AB16	210 mm

- To strip off and cut flexible cables 0,03 - 16 mm<sup>2</sup>
- Integrated blade with safety lock
- Adjustable length

■ ATTENTION: NOT SUITABLE FOR WORK UNDER VOLTAGE!



### Universal cable stripper

APPLICATION RANGE	Ø 6 - 16 mm <sup>2</sup>
INSULATION THICKNESS	ANY
SUGGESTED APPLICATION	outer PVC insulation

Description	Order No.	Length
Universal cable stripper	AV8203	170 mm

- To strip off flexible cables 6 - 16 mm<sup>2</sup>

■ ATTENTION: NOT SUITABLE FOR WORK UNDER VOLTAGE!

## STRIPPING TOOLS FOR EXTERNAL INSULATION



### AMS / AMS 1000V - Universal cable stripper for external insulation

APPLICATION RANGE	Ø > 25 mm
INSULATION THICKNESS	0 - 5 mm
SUGGESTED APPLICATION	PVC / Rubber

#### Technical characteristics:

- Designed to strip outer sheath from MV and LV cables
- Longitudinal and circular cuts
- Designed to strip ends and or middle parts
- Stripping without hurting the lower layers
- Interchangeable two-sided blade
- Snap closure mechanism (AMS only)

#### Additional features model AMS 1000V - 17130:

- Suitable for work on live parts up to 1000V AC und 1500V DC (model AMS 1000V - 1713 0 only)
- Model AMS 1000V is also designed for very low temperature uses, down to -40°C



Universal cable stripper AMS - AV6221



AMS-Set - AV6220



Universal cable stripper AMS 1000V - 1713 1



AMS 1000V-Set - 1713 0

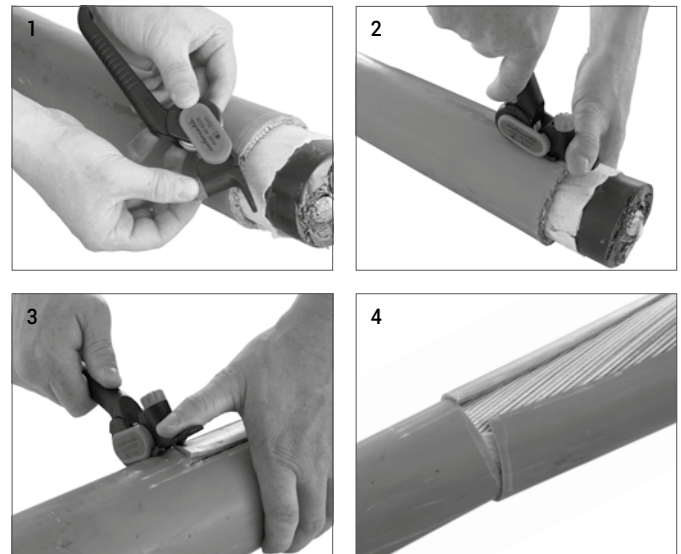

- NO DAMAGING OF BELOW SURFACE
- SUITABLE FOR WORK ON LIVE PARTS (ONLY MODEL 17130)
- LONG LASTING PRECISE INTERCHANGEABLE TWO SIDED BLADE

Description	Order No.	Dimensions	Weight
Set: AMS	AV6220	160 x 65 x 35 mm	200 g
Set: AMS 1000V	17130	170 x 75 x 50 mm	200 g
Spare blade	AV6299	-	-

#### Set equipment:

- Plastic case to contain the tool and its instructions for use (AMS)
- Soft nylon case to contain the tool and its instructions for use (AMS 1000V)

## STRIPPING TOOLS FOR EXTERNAL INSULATION

2



Universal cable stripper AMS MAXI - AV6240

### AMS MAXI - Universal cable stripper for large difficult cable insulation

APPLICATION RANGE	Ø > 45 mm
INSULATION THICKNESS	0 - 5 mm
SUGGESTED APPLICATION	PVC / Rubber / Polyethylene

#### Technical characteristics:

- Designed to strip outer sheath from LV, MV and HV cables
- Longitudinal and circular cuts
- Designed to strip ends or middle parts
- Stripping without hurting the lower layers
- Interchangeable two-sided blade

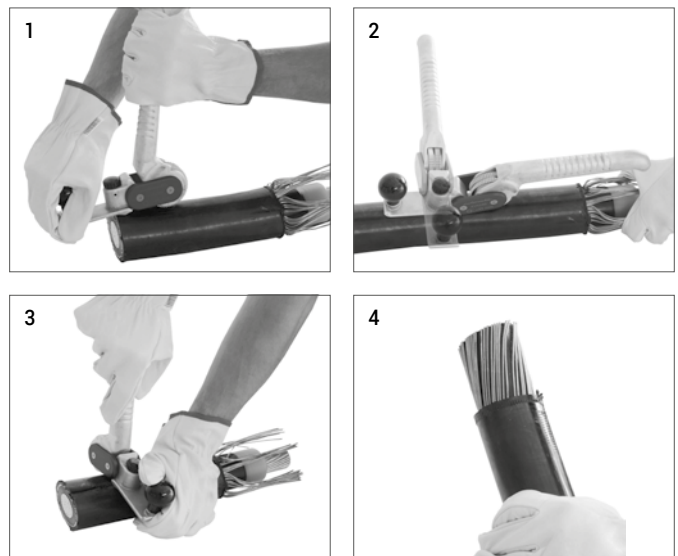

- NO DAMAGING OF BELOW SURFACE
- LONG LASTING PRECISE INTERCHANGEABLE TWO SIDED BLADE
- SUITABLE TO WORK ON LARGE DIFFICULT CABLES INSULATION



AMS MAXI-Set - AV6240

Description	Order No.	Dimensions	Weight
Set: AMS MAXI	AV6240	250 x 110 x 60 mm	800 g
Spare blade	AV6299	-	-

■ ATTENTION: NOT SUITABLE FOR WORK UNDER VOLTAGE!

#### Set equipment:

- Soft nylon case to contain the tool and its instructions for use



## STRIPPING TOOLS FOR EXTERNAL INSULATION

### MSU - Special cable stripper for external insulation

APPLICATION RANGE	Ø 24 - 60 mm
INSULATION THICKNESS	0 - 5 mm
SUGGESTED APPLICATION	Polyethylene / lead cables

#### Technical characteristics:

- Designed to strip outer sheath from MV and LV cables
- Circular and helical cuts
- Operates by simply rotating it around the cable axis
- Designed to strip both ends
- Interchangeable blade

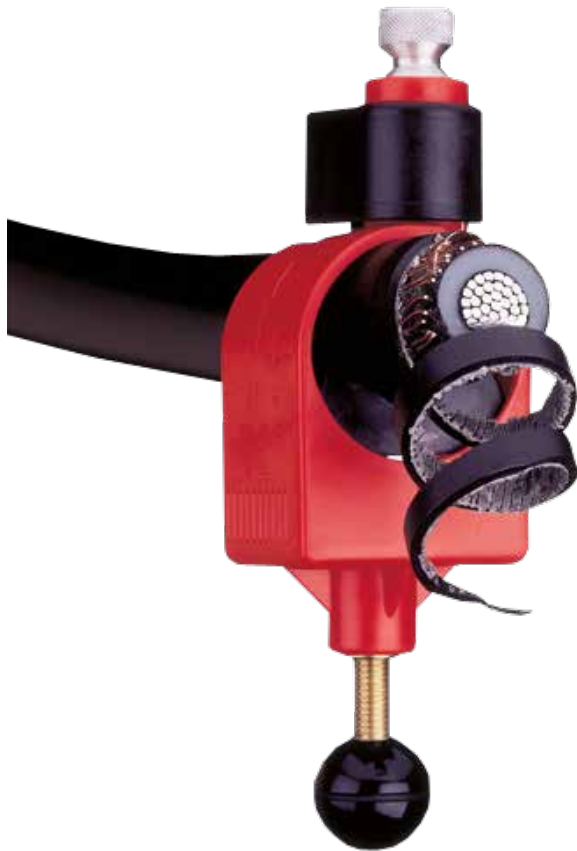

MSU - AE6210



Cable knife - AV3920



Soft case - AB6210

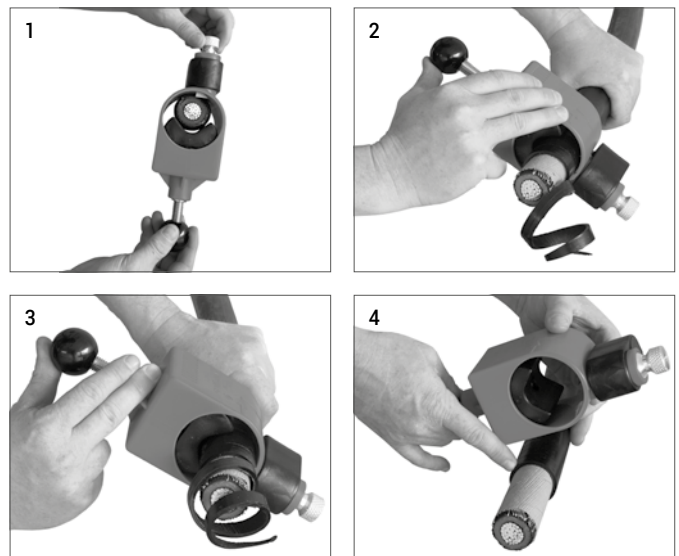

- NO DAMAGING OF BELOW SURFACE
- SUITABLE FOR WORK ON LIVE PARTS (ONLY MODEL 17130)
- LONG LASTING PRECISE INTERCHANGEABLE TWO SIDED BLADE

Description	Order No.	Dimensions	Weight
Set: MSU	AE6210	290 x 110 x 90 mm	900 g
Spare blade	AE6219	-	-

■ ATTENTION: NOT SUITABLE FOR WORK UNDER VOLTAGE!

#### Set equipment:

- Special MSU cable stripper ..... AE6211
- Cable knife ..... AV3920
- Soft case ..... AB6210

## STRIPPING TOOLS FOR EXTERNAL INSULATION

2



Norm: EN10020



Cable stripper AMX - 1730 0-LOSE



Feed lever - 1719 4



Soft nylon case - AB6230

### AMX - Universal cable stripper for heavy duty outer sheaths

APPLICATION RANGE	Ø 16 - 54 mm
INSULATION THICKNESS	0 - 5 mm
SUGGESTED APPLICATION	Polyethylene / fully bonded aluminium outer insulation

#### Technical characteristics:

- Designed to strip aluminium armed outer sheaths of LV/MV
- Suitable for longitudinal and circular cutting
- Additional claw to break hard insulation
- The initial setting of the correct cable diameter is done by adjusting the handle
- The fixation of the device on the cable is performed by a quick-release system with toggle lever principle
- The cutting depth is adjustable in steps of 0,1 mm
- Switchable between longitudinal and circular cut
- Maximal rotation diameter of the tool: 300 mm

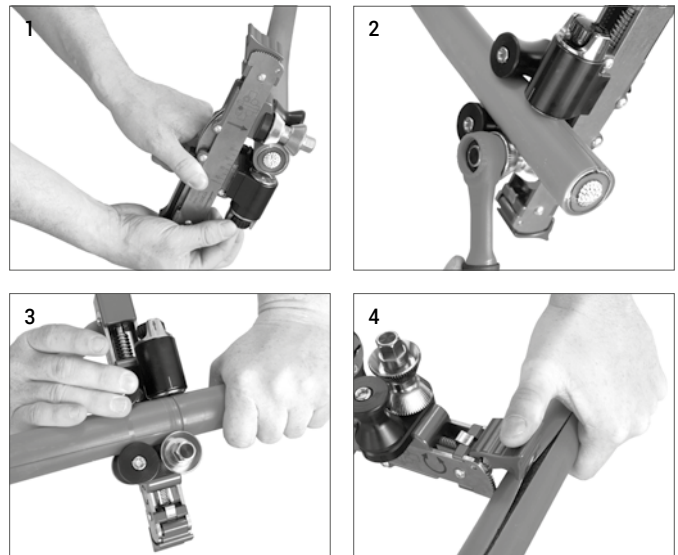

- SMALL SELF ROTATING TO WORK ON LIMITED SPACE
- EASY AND PRECISE WORKING THROUGH FAST LOCKING SYSTEM
- GRADUALLY DEPTH ADJUSTMENT AND MAX. SAFETY OF OPERATOR

Description	Order No.	Dimensions	Weight
Set: AMX	17300	260 x 140 x 65 mm	1,3 kg
Spare blade	17301	-	-

■ ATTENTION: NOT SUITABLE FOR WORK UNDER VOLTAGE!

#### Set equipment:

- AMX - cable stripper ..... 1730 0
- Feed lever ..... 1719 4
- 2,5 mm Allen wrench ..... 1710 1
- Soft nylon case ..... AB6230

## STRIPPING TOOLS FOR EXTERNAL INSULATION

### AIS - Cable stripper for external insulation

APPLICATION RANGE	Ø 16 - 54 mm
INSULATION THICKNESS	0,5 - 5 mm
SUGGESTED APPLICATION	High density polyethylene

#### Technical characteristics:

- Longitudinal and circular cuts on MV cables
- Used to work on live parts up to 1000V AC and 1500V DC
- Designed to strip ends or middle parts
- Hooked blade for removing the sheath that has been cut
- 100° tool rotation makes a complete 360° circumference cut
- Longitudinal feed in both directions using the ratchet lever
- Electrically insulated interchangeable blades
- Two-component handles in compliance with CEI/EN60900 Standards
- The tool head (except for the blades) is totally insulated



Cable stripper AIS - 1719 6



Feed lever - 1719 4



AIS-Set - 1719 0



- ADJUSTABLE CUTTING DEPTH LIMITATION
- SUITABLE TO WORK ON LIVE PARTS
- FEED LEVER FOR PRECISE WORKING AND MAX. SAFETY OF OPERATOR

Description	Order No.	Dimensions	Weight
Set: AIS	17190	390 x 340 x 90 mm	2,0 kg
Spare blade	17195	-	-

#### Set equipment:

- AIS - cable stripper ..... 1719 6
- Feed lever ..... 1719 4
- 10 x 14 Colored identification washers ..... -
- 2 Spare screws to fasten the blade ..... 1719 7
- 2,5 mm Allen wrench ..... 1710 1
- Rigid resin case ..... AB17190

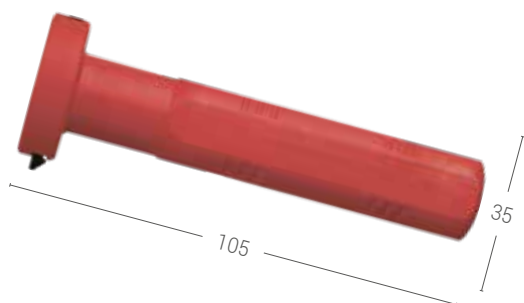

Insulated handle - 1717 1



Stripping insert - 1717...



FSI 150 - Set - 1717 0

### FSI 150 - Insulated wire stripper for ABC cables

APPLICATION RANGE	6 - 150 mm <sup>2</sup>
INSULATION THICKNESS	Preadjusted stripping inserts
SUGGESTED APPLICATION	ABC cables (overhead, twisted, insulated)

#### Technical characteristics:

- Designed to work on live parts up to 1000V AC and 1500V DC
- Stripping depth adjustment built inside the handle
- Insulated handle with bayonet connection
- Stripping length adjustable from 20 to 80 mm
- Scale marked on the built-in device to display the preset length
- Interchangeable blade

#### Inserts available:

- Stripping insert 6 mm<sup>2</sup> ..... 1717 006
- Stripping insert 10 mm<sup>2</sup> ..... 1717 010
- Stripping insert 16 mm<sup>2</sup> ..... 1717 016
- Stripping insert 25 mm<sup>2</sup> ..... 1717 025
- Stripping insert 35 mm<sup>2</sup> ..... 1717 035
- Stripping insert 50 mm<sup>2</sup> ..... 1717 050
- Stripping insert 54,6 mm<sup>2</sup> ..... 1717 054
- Stripping insert 70 mm<sup>2</sup> ..... 1717 070
- Stripping insert 95 mm<sup>2</sup> ..... 1717 095
- Stripping insert 150 mm<sup>2</sup> ..... 1717 150
- Other inserts on request

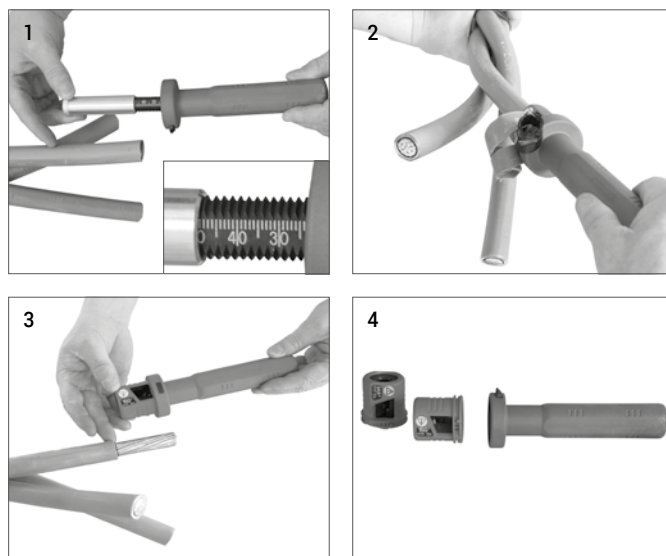

- EASY HANDLING THROUGH PREADJUSTED INSERTS
- SUITABLE TO WORK ON LIVE PARTS 1000V
- DESIGNED TO WORK IN LIMITED SPACE

Description	Order No.	Dimensions	Weight
Set: FSI 150	17170	235 x 210 x 55 mm	950 g
Spare blade	17179	-	-

#### Set equipment:

- Insulated handle ..... 1717 1
- Stripping inserts: 16, 25, 35, 50, 54,6, 70 mm<sup>2</sup>
- 3 Spare blades ..... 1717 9
- Allen wrench 2,5 mm ..... 1710 0
- Rigid resin case ..... AB17170

## STRIPPING TOOLS FOR EXTERNAL INSULATION



### FSI - Insulated wire stripper for cables from 2.5 to 10 mm<sup>2</sup>

RIGID SINGLE POLE	10 mm <sup>2</sup>
FLEXIBLE SINGLE POLE	2,5 - 4 - 6 mm <sup>2</sup>

#### Technical characteristics:

- 20 mm stripping depth
- Blade built into the tool
- The tool can be used with one hand only and allow easy stripping of cables lengths of 20 mm
- The tool is provided with two hand - guards. Central handling permits all stripping operations
- Blades are located in a secure position to prevent accidental contact with worker's hands during the stripping operations and to assure the clean stripping of the insulation



Wire stripper - AE6200

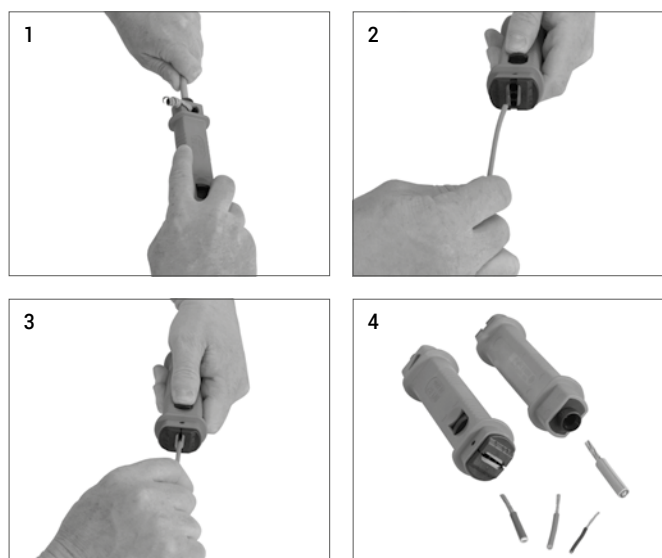

- EASY HANDLING THROUGH PREADJUSTED INSERTS
- SUITABLE TO WORK ON LIVE PARTS 1000V
- DESIGNED TO WORK IN LIMITED SPACE



Soft nylon case - AB6200

Description	Order No.	Dimensions	Weight
Set: FSI	AE6200	175 x 65 x 50 mm	150 g

#### Set equipment:

- Insulated stripping tool ..... AE6200
- Soft nylon case ..... AB6200

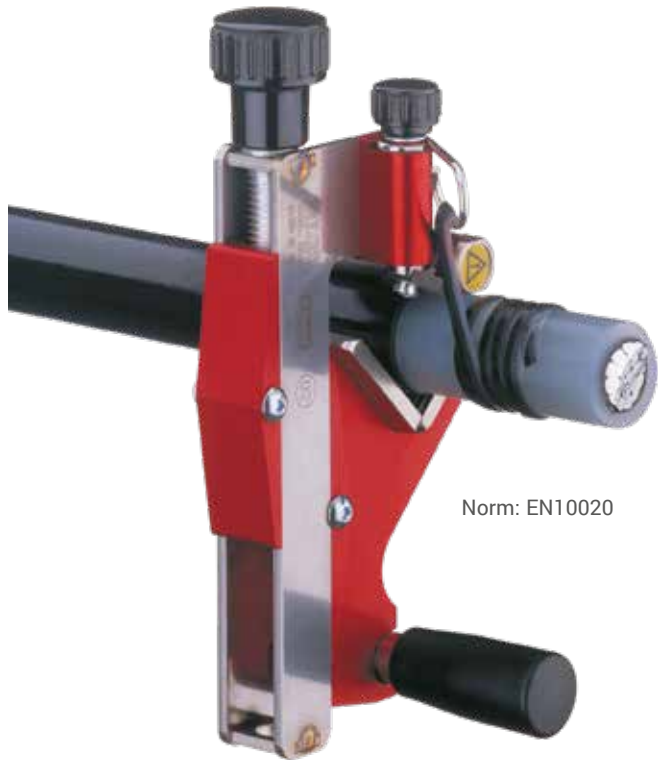

Norm: EN10020

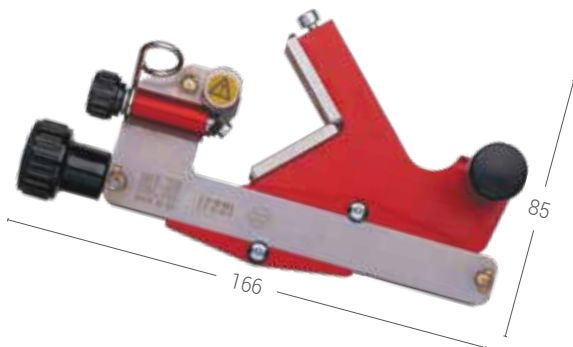

Cable stripper FBS - 1722 1



FBS-Set - 1722 0

### FBS - Cable stripper for vulcanized semiconductive layer

APPLICATION RANGE	Ø 10 - 52 mm
INSULATION THICKNESS	0 - 1,5 mm
SUGGESTED APPLICATION	Vulcanized, extruded, bonded semiconductive layer

#### Technical characteristics:

- Positioning on the cable comparable to a vice system
- Axial feed activation/deactivation device (usable in both directions):  
Through the stripping operation starting from outside of the cable, 25mm of the semicon layer will not be stripped (as shown in the pictures). By the stripping operation from inside to outside about 6 mm of semicon layer will remain.
- Stripping can be done starting from any position on the cable
- Maximal rotating diameter 200 mm
- Interchangeable blade

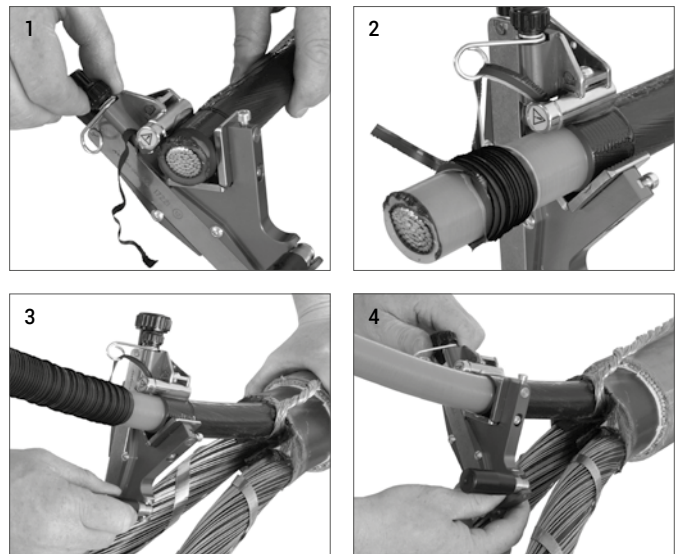

- SMALL AND COMPACT DESIGN
- PERFECT CIRCULAR CUT
- STEP BY STEP DEPTH ADJUSTMENT (WITH LOCKING POSSIBILITY)

Description	Order No.	Dimensions	Weight
Set: FBS	17220	235 x 200 x 55 mm	800 g
Spare blade 17"	17142	-	-
Spare parts kit (2x plates, 1x roll, suitable screws)	17145	-	-

■ ATTENTION: NOT SUITABLE FOR WORK UNDER VOLTAGE!

#### Set equipment:

- FBS - cable stripper ..... 1722 1
- 2,5 mm Allen wrench ..... 1710 0
- Tube of silicone grease ..... AG1013
- Rigid resin case ..... AB17220

## STRIPPING TOOLS FOR SEMICONDUCTOR

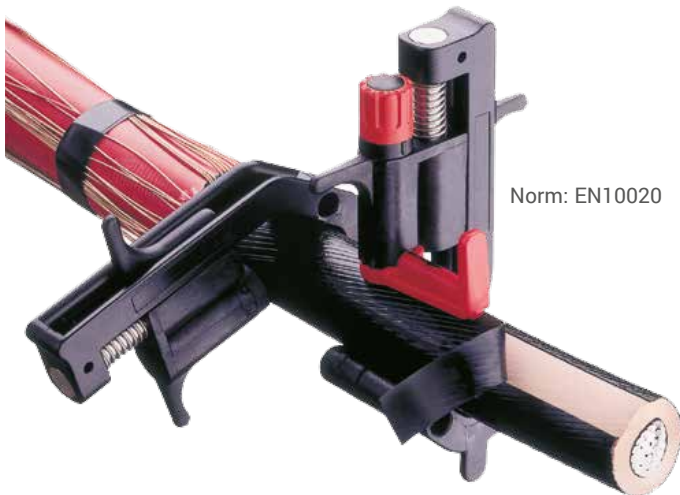

Norm: EN10020

### HLS - Cable stripper for non-vulcanized semiconductive layer

APPLICATION RANGE	Ø 16 - 41 mm
INSULATION THICKNESS	0 - 2 mm
SUGGESTED APPLICATION	Non vulcanized, peelable semiconductive layer

#### Technical characteristics:

- To strip the non-vulcanized semiconductive layer of MV cables
- Longitudinal, helical and circular cuts
- Positioned on the cable comparable to a vice system
- Stop clamp to limit the stripping length
- Gradually depth adjustment
- Maximal rotating diameter 130 mm
- The positioning of the stripper and holding of stops-clamp is assured by the pressure of the spring
- The incision depth can be adjusted from 0 to 0,9 mm with 0,1 mm steps each by turning the corresponding knob
- The start of longitudinal incision can be done in exact correspondence with the circumferential incision.

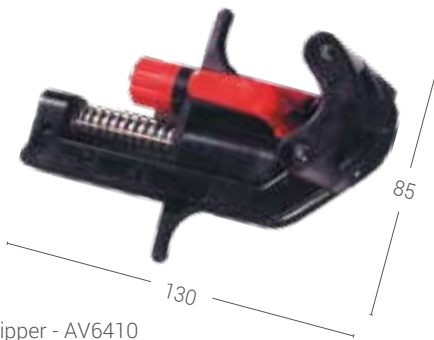

Cable stripper - AV6410



Stop clamp - AV6411

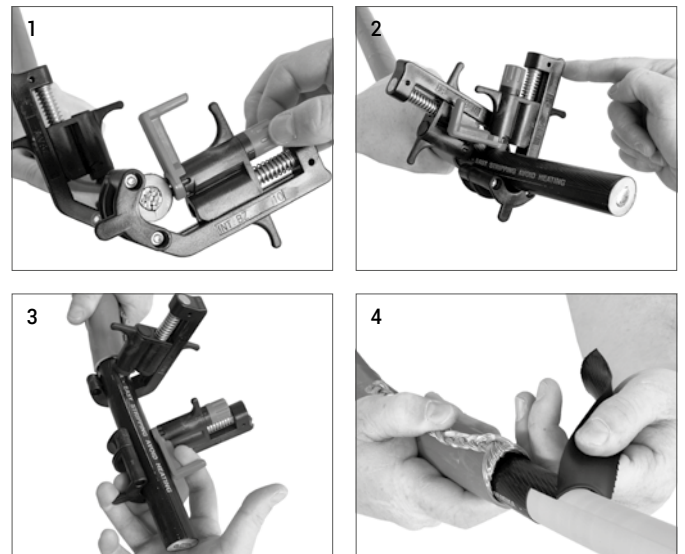

- SMALL AND COMPACT DESIGN
- PERFECT PRECISE CIRCULAR CUT
- NO INCISIONS ON SURFACE BELOW

Description	Order No.	Dimensions	Weight
Set: HLS	AV6400	175 x 65 x 50 mm	600 g
Spare blade	AV6499	-	-

■ ATTENTION: NOT SUITABLE FOR WORK UNDER VOLTAGE!

#### Set equipment:

- HLS - cable stripper ..... AV6410
- Stop clamp ..... AV6411
- Tube of silicone grease ..... AG1013
- Rigid resin case ..... AB6400



HLS-Set - AV6400



Norm: EN10020

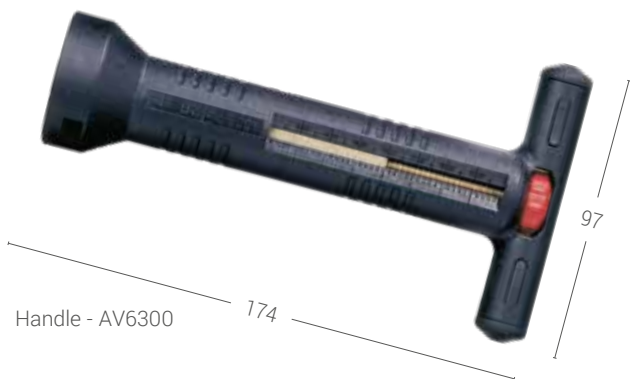

Handle - AV6300



Stripping insert - AV63...

### IMS - Cable stripper for primary insulation

APPLICATION RANGE	25 - 240 mm <sup>2</sup>
INSULATION THICKNESS	Preadjusted stripping inserts
SUGGESTED APPLICATION	Any type of primary insulation

#### Technical characteristics:

- Suitable for MV cables 10/11kV or 20/22kV
- Stripping length adjustable from 20 to 100 mm using the device integrated in the handle
- Scale marked on the handle for preset stripping length
- Handle with bayonet connection
- Interchangeable blade

#### Inserts available:

##### 10 - 11kV

- Insert for 35 mm<sup>2</sup> ..... 1716021
- Insert for 50 mm<sup>2</sup> ..... 1716024
- Insert for 120 mm<sup>2</sup> ..... 1716013
- Insert for 150 mm<sup>2</sup> ..... 1716027
- Insert for 185 mm<sup>2</sup> ..... 1716020
- Insert for 240 mm<sup>2</sup> ..... 1716006

##### 20 - 22kV

- Insert for 25 mm<sup>2</sup> ..... AV63025
- Insert for 35 mm<sup>2</sup> ..... AV63035
- Insert for 50 mm<sup>2</sup> ..... AV63050
- Insert for 70 mm<sup>2</sup> ..... AV63070
- Insert for 95 mm<sup>2</sup> ..... AV63095
- Insert for 120 mm<sup>2</sup> ..... AV63120
- Insert for 150 mm<sup>2</sup> ..... AV63150
- Insert for 185 mm<sup>2</sup> ..... AV63185
- Insert for 240 mm<sup>2</sup> ..... AV63240

Other inserts available on request (10kV, 30kV, customized sizes), by sending PE-Coating Ø and Conductor Ø in mm

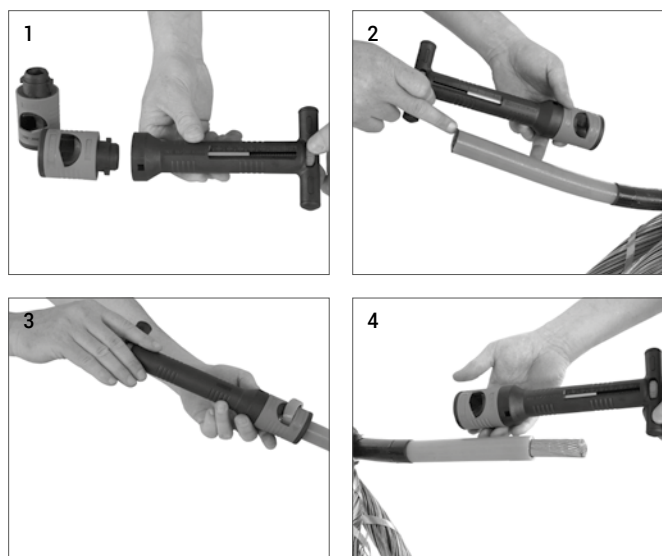

- EASY HANDLING THROUGH PREADJUSTED INSERTS
- ADJUSTABLE STRIPPING LENGTH
- DESIGNED TO WORK IN LIMITED SPACE

Description	Order No.	Dimensions	Weight
Set: IMS 20kV	AV6310	330 x 290 x 75 mm	600 g
Set: IMS 20kV + AMS	AV6320	330 x 290 x 75 mm	1,70 kg
Spare blade	AV6399	-	-

■ ATTENTION: NOT SUITABLE FOR WORK UNDER VOLTAGE!

#### Set equipment: - AV6310:

- Handle ..... AV6300
- Stripping inserts 25, 35, 50, 70, 95, 120, 150, 185, 240 mm<sup>2</sup>
- Rigid resin case ..... AB6300

#### Set equipment - AV6320 like model AV6310 including:

- AMS - cable stripper ..... AV6221



IMS 20kV-Set - AV6310



STRIPPING TOOLS FOR PRIMARY INSULATION



Cable stripper for primary insulation

APPLICATION RANGE	300 or 400 mm <sup>2</sup>
INSULATION THICKNESS	Preadjusted stripping inserts
SUGGESTED APPLICATION	Any type of primary insulation

Technical characteristics:

- Suitable for MV cables 10/11kV or 20/22kV
- Unlimited stripping length
- Devise with two integrated handles
- Interchangeable blade
- Designed to strip both ends

- UNLIMITED STRIPPING LENGTH
- EXCELLENT TO WORK IN EMPTY SPACE
- COMFORTABLE HANDLING



Description	Order No.	Dimensions	Weight
Stripping insert for 300 mm <sup>2</sup>	AV63300	231 x 90 mm	1380 g
Stripping insert for 400 mm <sup>2</sup>	AV63400	231 x 90 mm	1330 g

2



Norm: EN10020



Stripping Tool IMS II - 1723 1



IMS II-Set - 1723 0

### IMS II - Universal cable stripper for primary insulation

APPLICATION RANGE	Ø 15 - 52 mm
INSULATION THICKNESS	0 - 15 mm
SUGGESTED APPLICATION	Any type of primary insulation

#### Technical characteristics:

- Designed to remove the primary insulation of 6 to 45kV cables
- Helical and circular cuts
- Max. rotating diameter 220 mm
- Snap knob to activate/deactivate axial feed
- Positioned on the cable like a vice system
- Designed to strip both ends
- Unlimited stripping length
- Interchangeable blade

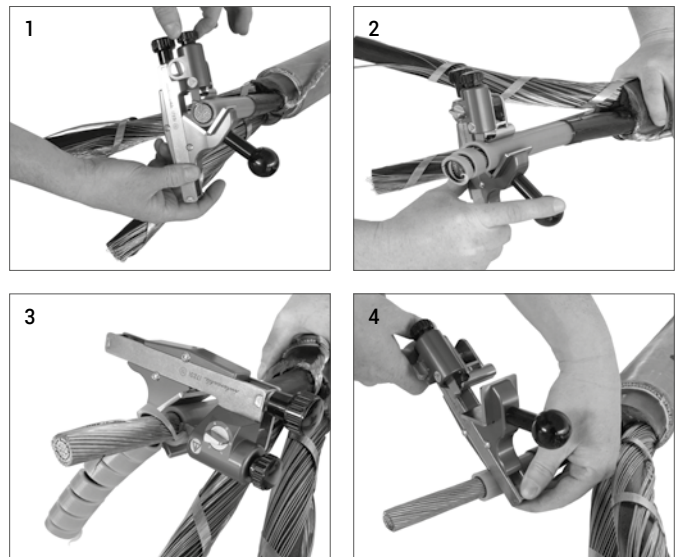

- REDUCED ROTATION ENABLES TO WORK ON LIMITED SPACE
- PERFECT CIRCULAR CUT
- NO INCISIONS ON SURFACE BELOW

Description	Order No.	Dimensions	Weight
Set: IMS II	17230	280 x 210 x 65 mm	1,0 kg
Spare blade	17232	-	-
Spare parts kit (2x plates, 1x roll, suitable screws)	17235	-	-

■ ATTENTION: NOT SUITABLE FOR WORK UNDER VOLTAGE!

#### Set equipment:

- IMS II - cable stripper ..... 1723 1
- 2,5 mm Allen wrench ..... 1710 0
- Tube of silicone grease ..... AG1013
- Rigid resin case ..... AB17230

## STRIPPING TOOLS FOR PRIMARY INSULATION

### UFS - Tool for chamfering primary insulation

APPLICATION RANGE	Ø 15 - 60 mm
SUGGESTED APPLICATION	Any type of primary insulation

#### Technical characteristics:

- Designed for chamfered cuts of primary insulation of MV cables (2 x 45°)
- Positioning on the cable with a clamp system
- Tool fitted with PTFE plates ensuring optimal sliding on the cable without the use of silicone paste
- Replaceable blade
- Rotation diameter max. 130 mm
- This tool is not suitable for pencilling

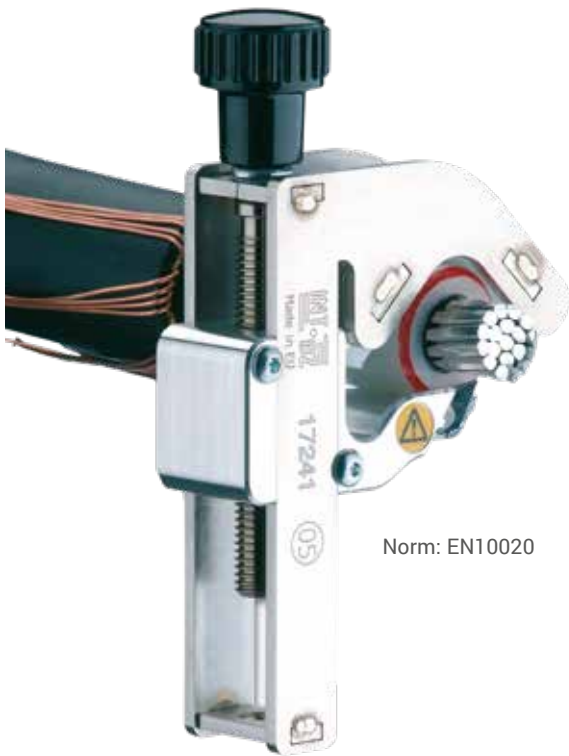

Norm: EN10020

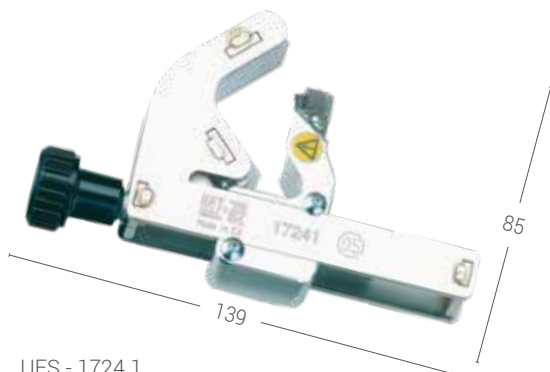

UFS - 1724 1



UFS-Set - 1724 0

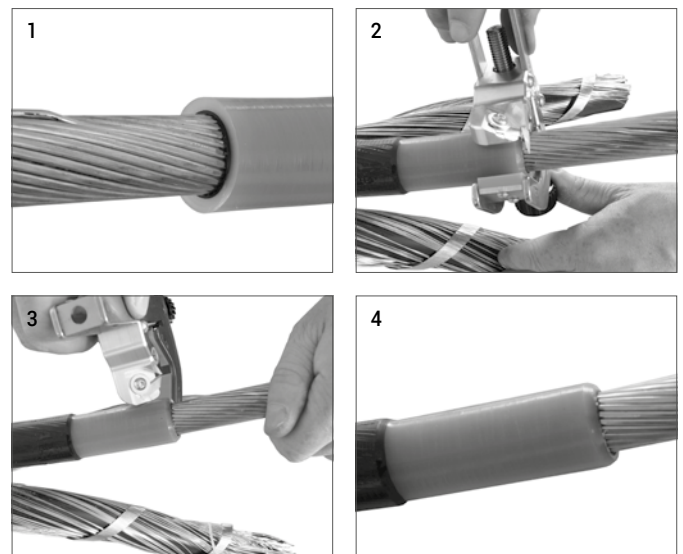

- SMALL SELFROTATING TO WORK ON LIMITED SPACE
- EASY HANDLING THROUGH 1 ADJUSTING KNOB
- UNIVERSAL UP TO 45 KV

Description	Order No.	Dimensions	Weight
Set: UFS	17240	170 x 100 x 50 mm	390 g
Spare blade	17242	-	-

■ ATTENTION: NOT SUITABLE FOR WORK UNDER VOLTAGE!

#### Set equipment:

- UFS - tool for chamfered cuts of primary insulation ..... 1724 1
- 2,5 mm Allen wrench ..... 1710 0
- Soft nylon case ..... AB17130

## CUTTING TOOL FOR ARMoured CABLE

2



Roller chains cutter - 1609076



Pressure spring RF5 - 126299

Available in different sizes  
(cable Ø 6-92 mm) on request



Soft nylon case - AB6230

### Roller chains cutter

APPLICATION RANGE	Ø 20 - 76 mm
SUGGESTED APPLICATION	Armoured cables

#### Technical characteristics:

- Designed for effortless and fast settling of the F-armor
- Practical tool, works in hard-to-reach areas small space for turning

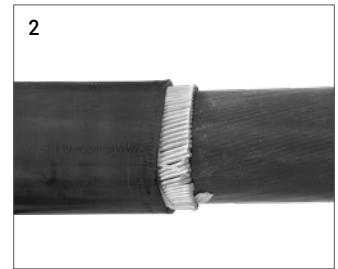
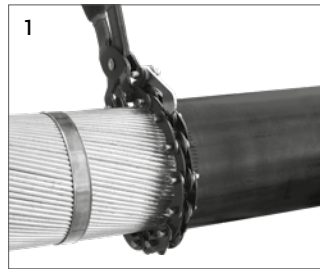

- PERFECT STRAIGHT CLEAN CUT
- QUICK SETTLING AROUND THE CABLE
- EASY HANDLING

Description	Order No.	Dimensions	Weight
Set roller chains cutter	1609076	260 x 140 x 65 mm	0,8 kg

■ ATTENTION: NOT SUITABLE FOR WORK UNDER VOLTAGE!

#### Set equipment:

- Roller chains cutter ..... 1609076
- Pressure spring RF5 ..... 126299
- Soft nylon case ..... AB6230

CUTTING TOOL FOR ARMOURED CABLE



**Set - Stripping tools - 1799 001**

Suitable to strip the outer sheaths, semiconductive layer and to remove the primary insulation. Optimal equipment for the realization of the entire stripping procedure of most diverse cable types.

Description	Order No.	Dimensions	Weight
Set: Stripping tools	1799001	390 x 340 x 100 mm	4,0 kg

**Set equipment:**

- AIS - cable stripper ..... 1719 6
- Feed lever ..... 1719 4
- 14 pieces of 10 colored indication washers ..... -
- 2 spare screws to fasten the blade ..... 1719 7
- FBS - cable stripper ..... 1722 1
- IMS II - cable stripper ..... 1723 1
- Tube of silicone grease ..... AG1013
- 2,5 mm Allen wrench ..... 1710 0
- Rigid resin case ..... 1799 000



**Set - Stripping tools - 1799 002**

Suitable to strip the outer sheaths, semiconductive layer and to remove the primary insulation. Optimal equipment for the realization of the entire stripping procedure of most diverse cable types

Description	Order No.	Dimensions	Weight
Set: Stripping tools	1799002	390 x 340 x 100 mm	3,0 kg

**Set equipment:**

- Universal cable stripper - AMS ..... AV6221
- IMS II - cable stripper ..... 1723 1
- FBS - cable stripper ..... 1722 1
- Cable knife ..... AV3920
- Special electricians scissors ..... 1601 0
- Tube of silicone grease ..... AG1013
- 2,5 mm Allen wrench ..... 1710 0
- Rigid resin case ..... AG3000

**Optional (to be ordered separately):**

- Handle IMS 20KV ..... AV6300
- 4 stripping inserts of your choice (see page xx) ..... AV63...

2



### Set - Stripping tools for MV cable

Suitable to strip the outer sheaths, semiconductive layer and to remove the primary insulation on 10 / 20 / 30 kV cables

Description	Order No.	Dimensions	Weight
Set: Stripping MV cable	1799004	390 x 340 x 100 mm	3,4 kg

#### Set equipment:

- AMX cable stripper ..... 1730 0
- Feed lever ..... 1719 4
- AMS cable stripper without case ..... AV6221
- FBS wire stripper ..... 1722 1
- Cable stripper IMS II ..... 1723 1
- UFS - tool for chamfered cuts of primary insulation ..... 1724 1
- Tube of silicone grease ..... AG1013
- 2,5 mm Allen wrench ..... 1710 0
- Rigid resin case ..... AB17250



### AMX - AIRBAG - Complete cable stripping tool set for AIRBAG-cable

Designed for complete stripping of individual sheaths from AIRBAG cables. AMX stripping pliers can also cut into the POLYLAM jacket without touching the semiconductive layer below

Description	Order No.	Dimensions	Weight
Set: AMX - AIRBAG	17210	390 x 340 x 100 mm	3,2 kg

#### Set equipment:

- AMX cable stripper ..... 1730 0
- Feed lever ..... 1719 4
- AMS cable stripper without case ..... AV6221
- FBS wire stripper ..... 1722 1
- Handle for IMS ..... AV6300
- Spec. 70 mm<sup>2</sup> stripping insert ..... 1716 012
- Spec. 185 mm<sup>2</sup> stripping insert ..... 1716 010
- 3 spare blades for IMS insert ..... AV6399
- Universal knife with blade guard ..... AV3910
- 3 spare blades for universal knife ..... AV3911
- Special electricians scissors ..... 1601 0
- Round jacket spread ..... 652 002
- Tube of silicone grease ..... AG1013
- 2,5 mm Allen wrench ..... 1710 0
- Rigid resin case ..... AB17240



1716 010 - Stripping insert for reduced insulation - section 185 mm<sup>2</sup>



1716 012 - Stripping insert for reduced insulation - section 70 mm<sup>2</sup>



### AIS - AIRBAG - Complete cable stripping tool set for AIRBAG-cable

Designed for complete stripping of individual sheaths from AIRBAG cables. AIS - AIRBAG stripping pliers can also cut into the POLYLAM jacket without touching the semiconductive layer below

Description	Order No.	Dimensions	Weight
Set: AIS - AIRBAG	17200	390 x 340 x 100 mm	3,2 kg
Set: AIS - AIRBAG red.	17201	390 x 340 x 100 mm	1,9 kg

#### Set equipment (1720 0):

- AIS - AIRBAG cable stripper ..... 1719 8
- Feed lever ..... 1719 4
- 2 blade fastening screws (spares) ..... 1719 7
- Set of spare blades with washers ..... 1719 9
- AMS cable stripper without case ..... AV6221
- FBS wire stripper ..... 1722 1
- Handle for IMS ..... AV6300
- Spec. 70 mm<sup>2</sup> stripping insert ..... 1716 012
- Spec. 185 mm<sup>2</sup> stripping insert ..... 1716 010
- 3 spare blades for IMS insert ..... AV6399
- Universal knife with blade guard ..... AV3910
- 3 spare blades for universal knife ..... AV3911
- Special electricians scissors ..... 1601 0
- Round jacket spread ..... 652 002
- Tube of silicone grease ..... AG1013
- 2,5 mm Allen wrench ..... 1710 0
- Rigid plastic case ..... AB17200

#### Reduced equipment (1720 1):

- AIS - AIRBAG cable stripper ..... 1719 8
- Feed lever ..... 1719 4
- Blade fastening screws (spares) ..... 1719 7
- Set of spare blades with washers ..... -
- 2,5 mm Allen wrench ..... 1710 1
- Rigid resin case ..... AB17200



### Set 1 - Stripping tools for armoured cables

Description	Order No.	Dimensions	Weight
Set 1	1799005	390 x 340 x 100 mm	3,2 kg

#### Set equipment:

- AMS cable stripper without case ..... AV6221
- FBS wire stripper ..... 1722 1
- Cable stripper IMS II ..... 1723 1
- UFS - tool for chamfered cuts of primary insulation ..... 1724 1
- Tube of silicone grease ..... AG1013
- Roller chains cutter ..... 1609076
- 2x pressure spring RF5 ..... 126299
- 2,5 mm Allen wrench ..... 1710 0
- Rigid resin case ..... AB17260

2



### Set 2 - Stripping tools for armoured cables

Description	Order No.	Dimensions	Weight
Set 2	1799006	390 x 340 x 100 mm	3,9 kg

#### Set equipment:

- Cable stripper AMS-MAXI without case ..... AV6240
- Cable stripper IMS II ..... 1723 1
- FBS wire stripper ..... 1722 1
- UFS - tool for chamfered cuts of primary insulation ..... 1724 1
- Roller chains cutter ..... 1609076
- 2x pressure spring RF5 ..... 126299
- Tube of silicone grease ..... AG1013
- 2,5 mm Allen wrench ..... 1710 0
- Rigid resin case ..... AB17260



### Set 3 - Stripping tools for armoured cables

Description	Order No.	Dimensions	Weight
Set 3	1799007	390 x 340 x 100 mm	3,7 kg

#### Set equipment:

- Cable stripper AMS-MAXI without case ..... AV6240
- Cable stripper IMS II ..... 1723 1
- UFS - tool for chamfered cuts of primary insulation ..... 1724 1
- HLS - cable stripper ..... AV6410
- Stop clamp ..... AV6411
- Roller chains cutter ..... 1609076
- 2x pressure spring RF5 ..... 126299
- Tube of silicone grease ..... AG1013
- 2,5 mm Allen wrench ..... 1710 0
- Rigid resin case ..... AB17260





**Set 4 - Stripping tools for armoured cables**

Description	Order No.	Dimensions	Weight
Set 4	1799008	390 x 340 x 100 mm	3,0 kg

**Set equipment:**

- AMS cable stripper without case ..... AV6221
- Cable stripper IMS II ..... 1723 1
- UFS - tool for chamfered cuts of primary insulation ..... 1724 1
- HLS - cable stripper ..... AV6410
- Stop clamp ..... AV6411
- Roller chains cutter ..... 1609076
- 2x pressure spring RF5 ..... 126299
- Tube of silicone grease ..... AG1013
- 2,5 mm Allen wrench ..... 1710 0
- Rigid resin case ..... AB17260



**Stripping tools KIT**

Description	Order No.	Dimensions	Weight
Set 5	1799013	390 x 340 x 100 mm	3,0 kg

**Set equipment:**

- AMS cable stripper without case ..... AV6221
- Cable stripper IMS II ..... 1723 1
- HLS - cable stripper ..... AV6410
- Stop clamp ..... AV6411
- Tube of silicone grease ..... AG1013
- 2,5 mm Allen wrench ..... 1710 0
- FBS wire stripper ..... 1722 1
- Rigid resin case .....

## CABLE JOINTERS CASE

2



### Tool kit for cable jointers

#### Basic equipment (AG2020):

• Case .....	AG2000
• 1/20 sliding caliper 150 mm .....	AG1001
• Measuring rod 3 m .....	7406 030
• Steel brush for files .....	AG1014
• Rasp without handle .....	AG1005
• Half round file with handle .....	AG1004
• Screwdriver slotted screws 3x100 mm FII .....	1301 030
• Screwdriver slotted screws 4x100 mm FII .....	1301 040
• Screwdriver slotted screws 5x125 mm FII .....	1301 055
• Ball-point screwdriver hex socket 6 mm FII .....	1305 060
• Mallet 300 g .....	7130 582
• Mallet Ø 35 mm .....	AG1010
• Sheath spreader .....	AG1011
• Special electricians' scissors .....	1601 1
• Cable knife with interch. blade .....	AV3920
• Spare blade for AV3920 .....	AV3921
• Knife with trapezoidal blade .....	AV3910
• 3 spare blades for AV3910 .....	AV3911
• High precision lens with light .....	AG1012
• Universal pliers 180 mm .....	AP0119 N
• Cable cutter 160 mm .....	AP1017
• Tube of silicone grease .....	AG1013
• 2,5 mm Allen wrench .....	1710 0



### Codes for kit with additional tools:

AG2020+...	A	B	C	D	E	F
	Ratchet cable cutter Ø 54 mm 	Cable stripper AMS (without case) (see page 69) 	Stripper MV cables IMS20kV (without case) (see page 78) 	Stripper non-vulcanized semiconductive - HLS (without case) (see page 77) 	Stripper vulcanized semiconductive - FBS (without case) (see page 76) 	Tool for chamfering primary insulation - UFS (without case) (see page 81) 

Example of ordering: AG2020ADF

#### Equipment:

- AG2020 - standard case
- A - ratchet cutter
- D - HLS stripper
- F - UFS chamfering tool

Description	Order No.	Dimensions	Weight
Basic tool kit	AG2020	450 x 380 x 200 mm	6,3 kg
Individual tool kit	AG2020...	450 x 380 x 200 mm	-
Empty case	AG2000	450 x 380 x 200 mm	3,7 kg